

RS500i

5.25" Coaxial Open-Ceiling Speaker

SOUNDTUBE
ENTERTAINMENT



Specifications: RS500i

Mounting hardware included

Nominal Impedance	8 ohm
Impedance (min)	4.9 ohm
Sensitivity dB @ 2.83V/1M	86.5dB
Sensitivity dB @ 1W/1M (2)	86.5dB
Frequency Response (± 3 dB)	87 Hz - 22 kHz
Frequency Response (± 10 dB)	61 Hz - 22 kHz
Max. Program Power	150W
Max. Continuous Power RMS	75W
Max. Power SPL @ 1 M	105.5dB
Tap Selector	6 Position rotary switch with transformer bypass
70.7 Volt Transformer Taps	33w / 101.5dB
100 Volt Transformer Taps (dB)	33w / 101.5dB
25 Volt Transformer Taps (dB)	5w / 93.5dB
Transformer Options	25 / 70.7 / 100 Volt with voice coil / 8 Ohm direct
Coverage Angle (-6 dB @ 2 kHz)	75
Colors	Black or white
Port length	5.18 in
Tweeter - part	76.1 mm (3.0 in.) Polypropylene driver w/ butyl rubber surround.
Woofer - part	5.25" Polypropylene
Inputs	4 Pin, 5.08 mm Euroblock for individual or daisy chain connection
Height (SM = Height)	298.2 mm / 11.74 in
Diameter (SM = Width)	245.9 mm / 9.68 in
Weight	4.3 kg / 9.47 lb
Shipping Weight	10 kg / 22.04 lb
Accessories Optional	Surface-Mount Bracket (AC-RS-SM5), Beam Clamp (AC-BC-1), Split Loom Tubing (AC-SLT-10), Hanging Kit (AC-RS-HH-10), Hanging Kit (AC-RS-HH-20), Hanging Kit (AC-RS-HH-50), Forged Eyebolt (AC-FE1), Snap Link (AC-SL-1)
Packaging	2 per box
Regulatory - UL	Approved UL1480A
Regulatory - CE	Approved
Regulatory - IP	not planned

RS500i

5.25" Coaxial Open-Ceiling Speaker

SOUNDTUBE
ENTERTAINMENT

Key Features

- Patented BroadBeam® waveguide technology delivers a consistent dispersion pattern up to 10 kHz for maximum coverage area per speaker (EASE™ documented).
- One 5.25 inch (133 mm) polypropylene woofer and one 1.0 inch (25 mm) convex titanium tweeter with FerroFluid cooling mounted to a proprietary castaluminum baffle and heat sink.
- Weatherized components for indoor and outdoor applications.
- Includes UL listed hanging hardware with cables and integrated SpeedClamp™ self-locking wire grip for fast, easy and secure installation. Also includes Euro-block connector and terminal weather boot.
- Patented ZeroReflection™ enclosure technology for optimal sound reproduction and cabinet rigidity.
- Easy-access, six-position selectable tap switch for 25-, 70.7- and 100-volt applications with a transformer bypass position simplifies ordering and inventory tracking.
- Plated steel grille with protective powdercoated finish for lasting durability.
- Average sensitivity 86.5 dB offers highoutput capabilities and reduced amplification costs.
- UL 1480 (UEAY), CE and Milspec 810 approved.
- High-quality black or white paint finish. Custom paint colors optional.
- Optional accessory: AC-RS-SM5 surface mount bracket

Description

One 5.25 inch polypropylene woofer and one 1.0 inch convex titanium tweeter with FerroFluid cooling mounted to a proprietary cast-aluminum baffle and heat sink. Includes UL listed hanging hardware with cables and integrated SpeedClamp™ self-locking wire grip for fast, easy and secure installation. Also includes Euro-block connector and terminal weather boot. Patented ZeroReflection™ enclosure technology for optimal sound reproduction and cabinet rigidity. Easy-access, six-position selectable tap switch for 25-, 70.7- and 100-volt applications with a transformer bypass position simplifies ordering and inventory tracking. Plated steel grille with protective powder-coated finish for lasting durability. Average sensitivity 86.5 dB offers high-output capabilities and reduced amplification costs. UL 1480 (UEAY), CE and Milspec 810 approved.

Applications

Designed for indoor and outdoor background to mid-level SPL applications, the RS500i includes a single-point mounting system for rapid open-ceiling installations. The broad dispersion pattern (105°) and high sensitivity (86.5 dB 1 W/1 m) make the RS500i speaker ideal for music and paging applications in

retail, grocery stores, restaurants, hotels, casinos, museums, trade shows and conference rooms. For applications where additional bass is required, SoundTube's RS1001i-II-T 10-inch subwoofer provides bass down to 38 Hz.

BroadBeam® Wide Dispersion Technology

SoundTube's proprietary BroadBeam® technology incorporates a highfrequency waveguide mated to a 1-inch convex titanium tweeter. The BroadBeam® high-frequency waveguide delivers a consistent dispersion pattern across the upper registers of the frequency spectrum (up to 10 kHz, independently verified). The result is better edge-to-edge coverage, reduced power needs, shorter installation time and cost savings on shipping and labor.

Patented SoundTube Technologies

SoundTube and MSE Audio Group constantly develop new technologies that enhance audio product performance. SoundTube innovations are protected by multiple U.S. and international patents, which explicitly cover SoundTube dispersion, enclosure and dome technologies. MSE Audio Group actively defends its patents in order to protect SoundTube resellers and end users.

Technical Data and Specification Tools

Technical Data

SoundTube Entertainment strives to provide complete and effective technical information and data to dealers, engineers and designers. All data are available from SoundTube Entertainment or at www.soundtube.com. Technical data and downloads include: EASE™ data - 3-D polar plots. EASE™ Address - 2-D modeling for distributed systems Autodesk® Revit® software Tech Sheets - Technical information and architectural specs for system engineers SoundTubeSPEC™ - Proprietary speaker placement software

Data Acquisition and Verification

All data for SoundTube speakers are independently collected from and verified by NWAALabs (www.nwaalabs.com) using their proprietary MACH testing system. All data are collected and analyzed according to ASTM, ISO and AES standards using EASRA, TEF and MLSSA. Full balloon data including both phase and magnitude are compiled into a variety of formats including EASE 4.x, GLL and CLF.

Architectural Specifications

The loudspeaker shall consist of a 133 mm (5.25 in.) low-frequency transducer and a 25 mm (1.0 in.) high-frequency transducer with a crossover installed in the ported enclosure. The low-frequency voice coil diameter shall be 25 mm (1.0 in.). Performance specifications of a typical production unit shall be as follows: Useable frequency response shall extend from 61 Hz - 22 kHz (-10 dB). Measured sensitivity (2.83-volt input, 1 meter) shall be at least 86.5 dB. The speaker shall have a nominal impedance of 8 ohms and be available for 25-, 70.7- and 100- volt modes with transformer bypass position. The frequency-dividing network shall have a crossover frequency of 3 kHz with slopes of 12 dB per octave (2nd order) for both low- and high-pass filters. Rated power capacity shall be at least 75 watts continuous (RMS) and conform to EIA-426-B testing. Maximum continuous output at 1 meter shall be 105.5 dB. RS500i Open-Ceiling Speaker Technical Information for System Engineers The low-frequency transducer shall have a polypropylene cone with butyl rubber surround. The high-frequency transducer shall be constructed of titanium with a proprietary BroadBeam® waveguide. Installation for the unit shall be by UL listed, galvanized steel cable affixed to the speaker chassis via an integrated snap-hook. For safety redundancy, a secondary cable shall be included. The external wiring input connector shall be a four-pin, 5.08 mm Euroblock for 8-ohm or distributed systems and shall accept from 10 - 22-gauge wire. The system shall be for indoor and outdoor applications and shall have a weather-resistant terminal boot covering all wire connectors. The enclosure shall be constructed of injection-molded, glass-reinforced ABS. The grille shall be constructed of powdercoated steel for lasting performance in the elements. Overall cabinet dimensions shall be no more than 298.3 mm (11.74 in.) in height by 245.9 mm (9.68 in.) in diameter. The speaker shall include hanging hardware, Euroblock connector and weather-resistant terminal boot. The system shall be the SoundTube RS500i with hanging applications for both low- and high-impedance applications.

SoundTube

8005 W. 110th St. | Suite 208
Overland Park, KS 66210
Phone 9136635600
Fax 8556635600
Toll Free 8556635600
<http://soundtube.mseaudio.com>
All SoundTube products come with a 5-year limited warranty.

RS500i

5.25" Coaxial Open-Ceiling Speaker

SOUNDTUBE ENTERTAINMENT

Graphs and Plots

Directivity Index

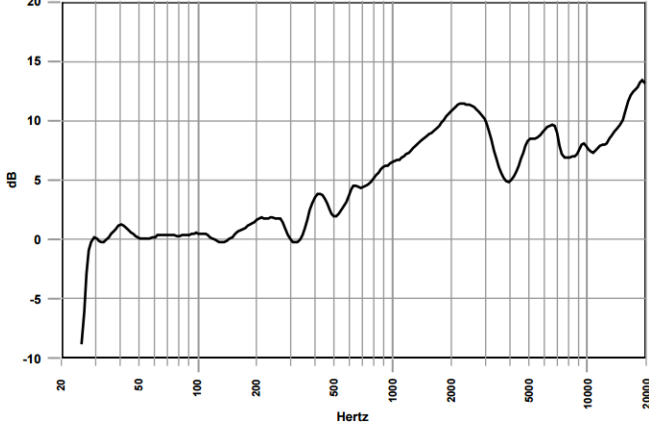

Frequency Response

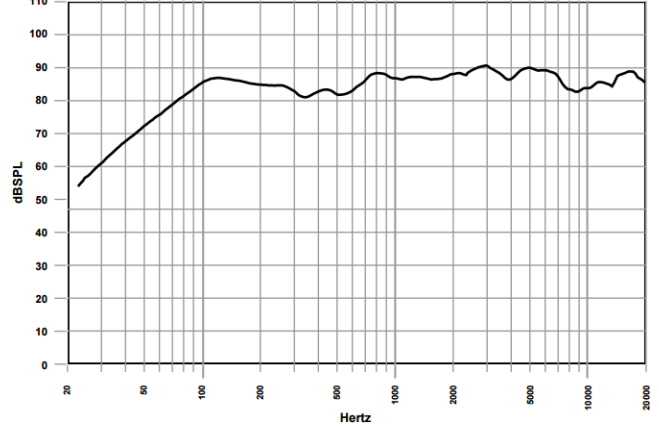

Phase/Impedance

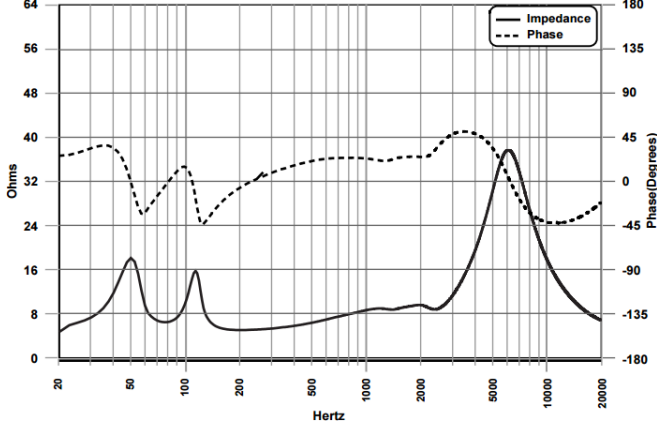

Vertical Beamwidth

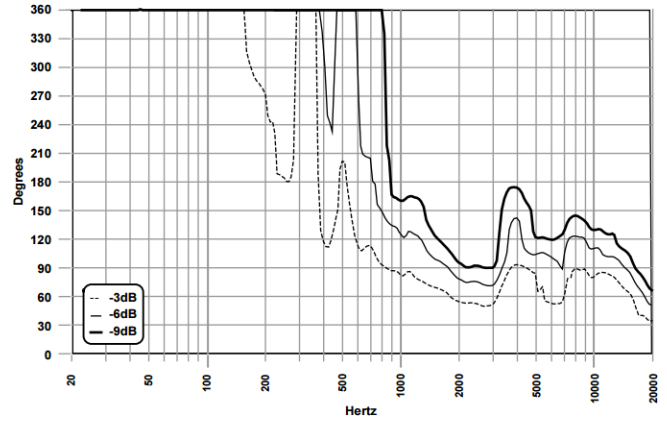

125 Hz

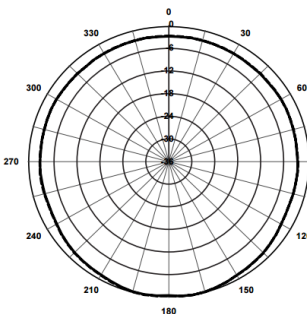

250 Hz

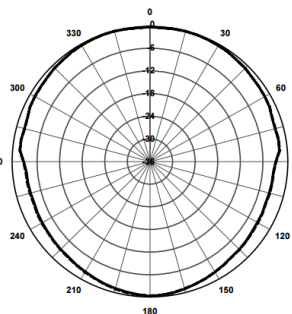

500 Hz

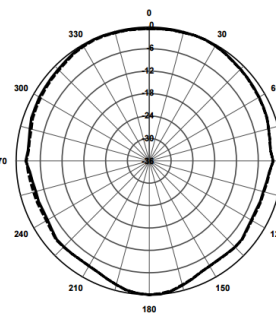

500 Hz

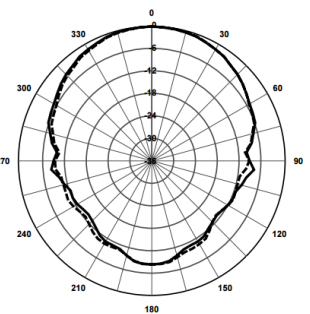

2000 Hz

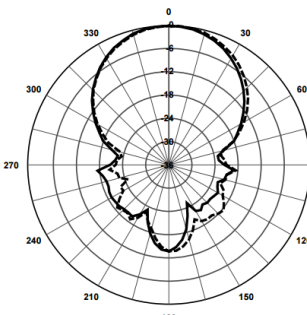

4000 Hz

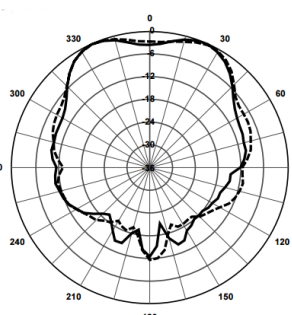

8000 Hz

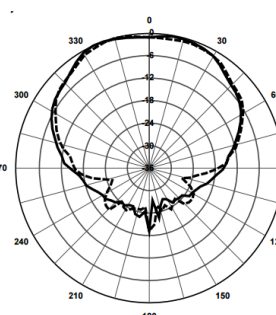

8000 Hz

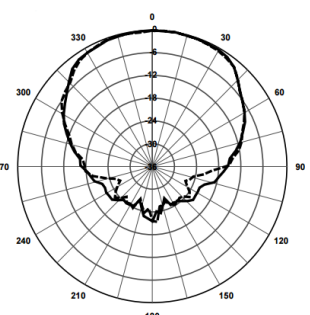

RS500i

5.25" Coaxial Open-Ceiling
Speaker

SOUNDTUBE
ENTERTAINMENT

Mechanical Drawings

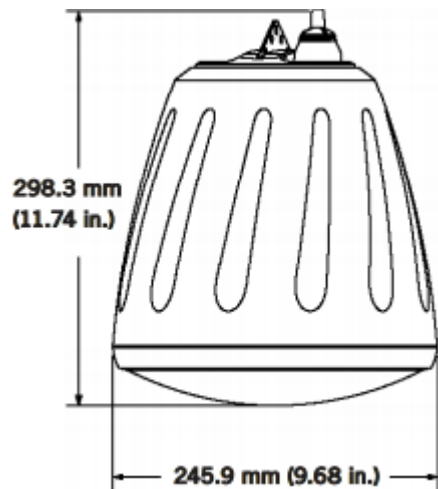

Included Accessories



Hanging Hardware: Main and Safety Cables w/ SpeedClamp™

Optional Accessories

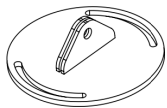

**Surface-Mount Bracket
(AC-RS-SM5)**

**Hanging Kit (AC-RS-
HH-10)**

Forged Eyebolt (AC-FE1)

Beam Clamp (AC-BC-1)

**Hanging Kit (AC-RS-
HH-20)**

Snap Link (AC-SL-1)

**Split Loom Tubing (AC-
SLT-10)**

**Hanging Kit (AC-RS-
HH-50)**