



Specifications: RS800i

Mounting hardware included

System Type	8-inch coaxial, open-ceiling, ported (66-watt transformer for 25/70.7/100-volt or transformer bypass applications)
Impedance (nominal) ¹	8 ohms
Sensitivity dB @ 2.83 V / 1 m	89.5 dB
Sensitivity dB @ 1 W / 1 m ²	89.5 dB
Frequency Response (-3 dB) ³	80 Hz - 22 kHz
Frequency Response (-10 dB) ³	58 Hz - 22 kHz
Max. Program Power ⁴	250 W
Max. Continuous Power RMS ⁵	125 W
Max. Power SPL @ 1 m ⁶	110.5 dB
Coverage Angle (-6 dB @ 2 kHz)	100°
Coverage Angle (-6 dB @ 10 kHz)	115°
Coverage Angle (averaged 2-10 kHz)	105°
Directivity Factor (Q)	4.7 (averaged 100 Hz - 10 kHz); 5.5 (2 kHz)
Directivity Index (DI)	5.8 (averaged 100 Hz - 10 kHz); 7.4 dB (2 kHz)
Tap Selector	Six-position rotary switch with transformer bypass
Transducer - Low-Frequency Driver	203 mm (8.0 in.) Polypropylene cone, butyl rubber surround
Transducer - High-Frequency Driver	25 mm (1.0 in.) Convex titanium tweeter with waveguide
Low-Frequency Voice Coil	30.4 mm (1.2 in.)
Crossover Frequency	3.0 kHz
Network Type: Low Pass	12 dB per octave, 2nd order
Network Type: High Pass	12 dB per octave, 2nd order
Enclosure Material	Injection molded ABS, glass fiber reinforced
Grille	Steel with powder-coat finish
Inputs	Four-pin, 5.08 mm Euroblock for individual or daisy chain connection
Colors	Black or white (paintable)
Height	437.6 mm (17.23 in.)
Diameter	376.4 mm (14.82 in.)
Weight	9.3 kg (20.5 lbs.)
Shipping Weight	11.6 kg (25.5 lbs.)
Packaging	One per box
Included Accessories	Hanging hardware, Euroblock connector and terminal weather boot
Optional Accessories	Surface-mount bracket (AC-RS-SM8)
Regulatory - UL	UL 1480 (UEAY) and 2239 (hanging cable) approved
Regulatory - CE	Approved
RoHS	Approved

Transformer Taps

	70.7 V	Output	100 V	Output	25 V	Output
1	66 W	107.5 dB	66 W	107.5 dB	9 W	99.0 dB
2	35 W	105.0 dB	35 W	105.0 dB	4.5 W	96.0 dB
3	19 W	102.5 dB	19 W	102.5 dB	2.3 W	93.0 dB
	10 W	99.5 dB	10 W	99.5 dB	1.1 W	90.0 dB
	5 W	96.5 dB				

1 Impedance listed per IEC 60268-5 with a minimum less than 80% the nominal impedance

2 1W 1m sensitivity determined using nominal impedance

3 Frequency response measured in half or full space as dictated by speaker mounting configuration

4 Max program power is 3 dB above max continuous power

5 Continuous power rating, EIA-426-B test

6 Max output based on max continuous power

Key Features

- Patented BroadBeam® waveguide technology delivers a consistent dispersion pattern for maximum intelligibility and edge-to-edge coverage (up to 10 kHz, independently verified).
- One 8.0 inch (203 mm) polypropylene woofer and one 1.0 inch (25 mm) convex titanium tweeter with FerroFluid cooling mounted to a proprietary cast-aluminum baffle and heat sink.
- Weatherized components for indoor and outdoor applications.
- Includes UL listed hanging hardware with galvanized steel cables and integrated SpeedClamp™ self-locking cable grip for fast, easy and secure installation. Also includes Euroblock connector and terminal weather boot.
- Patented ZeroReflection™ enclosure technology for optimal sound reproduction and cabinet rigidity.
- Easy access six-position selectable tap switch for 25-, 70.7- and 100-volt applications with transformer bypass position simplifies ordering and inventory tracking.
- Steel grille with protective powder-coated finish for lasting durability.
- Average sensitivity of 89.5 dB offers high-output capabilities and reduced amplification costs.
- UL 1480 (UEAY), 2239 (hanging cable) and Milspec 810 approved.
- High-quality black or white paint finish. Custom paint colors optional.
- Optional accessory: AC-RS-SM8 bracket for surface-mount applications.

Description

The RS800i is an 8-inch, two-way, ported speaker with an open-ceiling enclosure design that delivers extended low-end response (58 Hz) and 105° off-axis performance (2 to 10 kHz, independently verified). SoundTube's proprietary BroadBeam® waveguide tweeter system delivers consistent high-performance audio across the operating bandwidth. The RS800i speaker design incorporates a low-profile grille, a proprietary motor-board, driver protection circuitry and a six-position tap switch with a transformer bypass position. Hanging hardware is included and features a SpeedClamp™



self-locking cable grip for fast, easy and secure installation.

Applications

Designed for indoor and outdoor background to mid-level SPL applications, the RS800i includes a single-point mounting system for rapid open-ceiling installations and has an optional bracket for surface-mount applications. The broad dispersion pattern (105°), true low-end response (58 Hz, -10 dB), and high sensitivity (89.5 dB 1 W/1 m) make the RS800i speaker ideal for big box stores, fitness centers, sports bars, multi-purpose rooms, churches, airports, theme parks, ballrooms, convention centers, casinos, and other open-ceiling applications. For applications where additional bass is required, SoundTube's RS1001i-II-T 10-inch subwoofer may be used with bass down to 38 Hz.

BroadBeam[®] Wide Dispersion Technology

SoundTube's proprietary BroadBeam[®] technology incorporates a high-frequency waveguide mated to a 1-inch convex titanium tweeter. The BroadBeam[®] high-frequency waveguide delivers a consistent dispersion pattern across the upper registers of the frequency spectrum (up to 10 kHz, independently verified). The result is an audio system with fewer speakers, reduced power needs, shorter installation time and cost savings on shipping and labor.

Patented SoundTube Technologies

SoundTube Entertainment and MSE Audio Group constantly develop new technologies that enhance audio product performance. SoundTube Entertainment innovations are protected by multiple U.S. and international patents, which explicitly cover SoundTube dispersion, enclosure and dome technologies. MSE Audio Group actively defends its patents in order to protect SoundTube resellers and end users.

Technical Data and Specification Tools

Technical Data

SoundTube Entertainment strives to provide complete and effective technical information and data to dealers, engineers and designers. All data are available from SoundTube Entertainment or at www.soundtube.com.

Technical data and downloads include:

EASE[™] data – 3-D polar plots.

EASE[™] Address – 2-D modeling for distributed systems

Autodesk[®] Revit[®] software

Tech Sheets – Technical information and architectural specs for system engineers

SoundTubeSPEC[™] – Proprietary speaker placement software

Data Acquisition and Verification

All data for SoundTube speakers are independently collected from and verified by NWAALabs (www.nwaalabs.com) using their proprietary MACH testing system. All data are collected and analyzed according to ASTM, ISO and AES standards using EASRA, TEF and MLSSA. Full balloon data, including both phase and magnitude, are compiled into a variety of formats, including EASE 4.x, GLL and CLF.

Architectural Specifications

The loudspeaker shall consist of a 203 mm (8.0 in.) low-frequency transducer and a 25.4 mm (1.0 in.) high-frequency transducer mounted in a patented Broadbeam[®] waveguide with a crossover network installed in the ported enclosure. The low-frequency voice coil diameter shall be 30.4 mm (1.2 in.).

Performance specifications of a typical production unit shall be as follows: Useable frequency response shall extend from 58 Hz – 22 kHz (-10 dB). Measured sensitivity (2.83-volt input, 1 meter) shall be at least 89.5 dB. The speaker shall have a nominal impedance of 8 ohms. The speaker shall be available for 25-, 70.7- and 100-volt modes and shall include a six-position tap switch with a transformer bypass position. The frequency-dividing network shall have a crossover frequency of 3 kHz with slopes of 12 dB per octave (2nd order) for both low- and high-pass filters. Rated power capacity shall be at least 125 watts continuous (RMS) and conform to EIA-426-B testing. Maximum continuous

output at 1 meter shall be 110.5 dB.

The low-frequency transducer shall have a polypropylene cone with butyl rubber surround. The high-frequency transducer shall be constructed of titanium with a proprietary BroadBeam[®] waveguide.

Installation for the unit shall be by UL listed, galvanized steel cable affixed to the speaker chassis via an integrated snap hook. For safety redundancy, a secondary cable shall be included. The external wiring input connector shall be a four-pin, 5.08 mm Euroblock for 8 ohm or distributed systems and shall accept from 10 – 22-gauge wire. The system shall have a weather-resistant boot covering all wire connectors.

The enclosure shall be constructed of injection-molded, glass-reinforced ABS. The grille shall be constructed of powder-coated steel for lasting performance in the elements. Overall cabinet dimensions shall be no more than 437.6 mm (17.23 in.) in height by 376.4 mm (14.82 in.) in diameter. The speaker shall include hanging hardware, Euroblock connector and weather-resistant terminal boot.

The system shall be the SoundTube RS800i with hanging hardware for both low- and high-impedance applications.

SoundTube Entertainment

6430 Business Park Loop Road
Park City, Utah 84098
Phone 435.647.9555
Fax 435.647.9666
Toll Free 800.647.TUBE
www.soundtube.com

All SoundTube products come with a 5-year limited warranty.

Graphs and Plots

Frequency Response

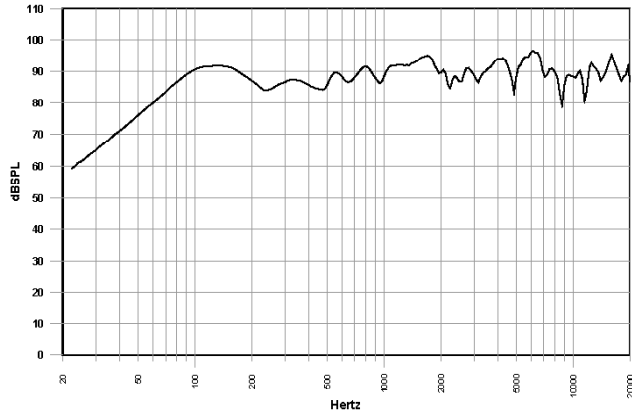

Impedance/Phase

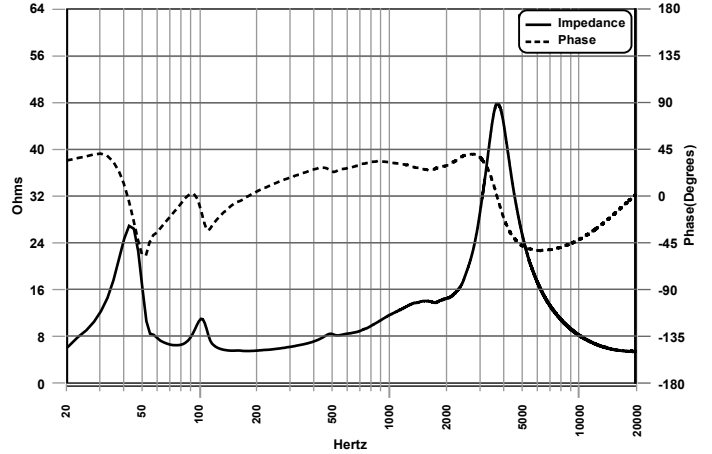

Vertical Beamwidth

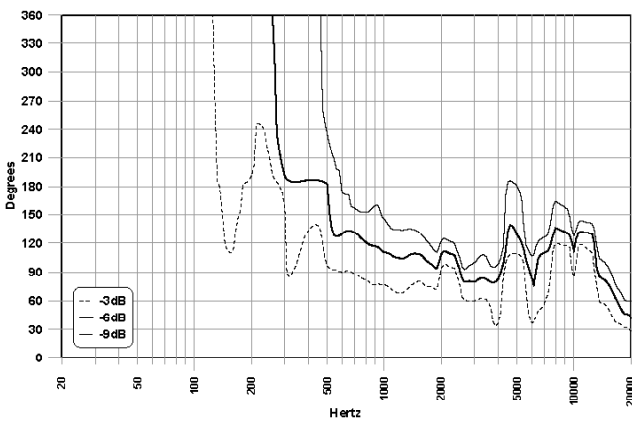

Directivity Index (DI)

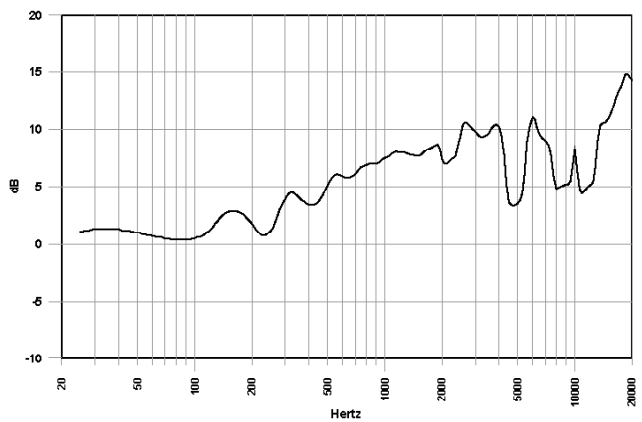



Polar Plots

— Horizontal
 - - - Vertical

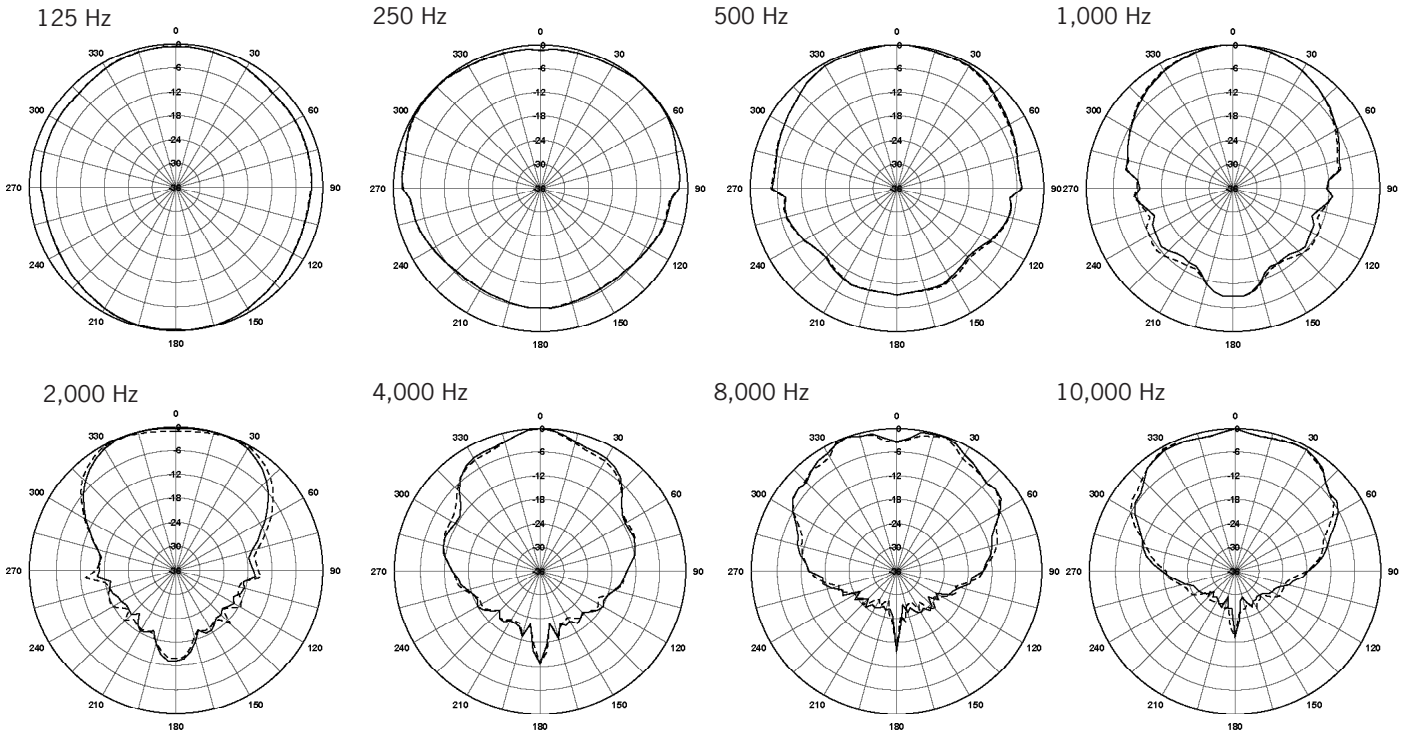

Mechanical Drawings

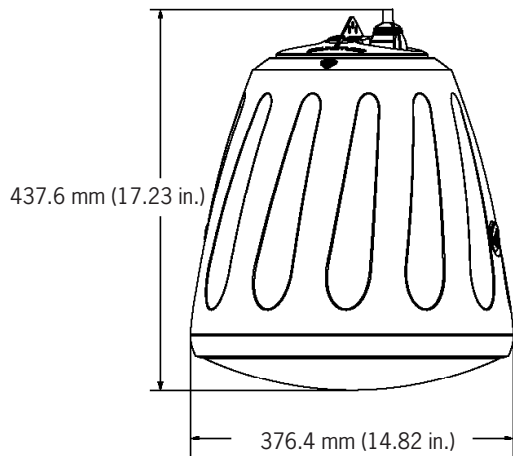

Included Accessories

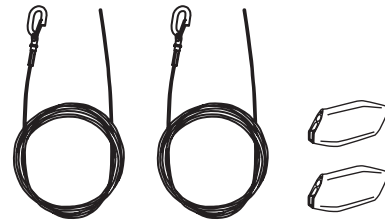

Hanging Hardware: Main and Safety Cables w/ SpeedClamp™

SoundTube's hanging cable kit incorporates hanging and safety cables and fasteners for an integrated and easy-to-install system. Hanging and safety cables are infinitely adjustable to 2.74 m (9.0 ft).

Optional Accessory

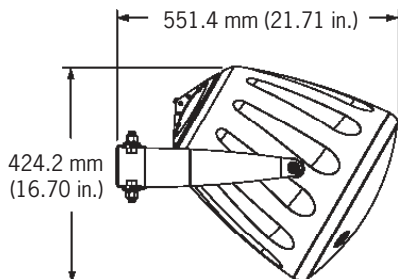

Surface-Mount Bracket (AC-RS-SM8)

SoundTube Entertainment manufactures a complete line of speakers for:
Open-Ceiling • In-Ceiling • Surface-Mount • Outdoor • Sound-Focusing

All SoundTube products are designed and engineered in the USA.