



Preliminary Specifications: IPD-CM52-BGM

Tile bridge included

System Type	5.25 inch coaxial, in-ceiling, ported, Dante™-enabled, network
Frequency Response (-3 dB) ¹	63 Hz - 20 kHz
Frequency Response (-10 dB) ¹	56 Hz - 22 kHz
Max. Power SPL @ 1 m ²	99.0 dB
Coverage Angle (-6 dB @ 2 kHz)	180°
Coverage Angle (-6 dB @ 10 kHz)	112°
Coverage Angle (averaged 2-10 kHz)	141°
Directivity Factor (Q)	3.8 (averaged 100 Hz - 10 kHz) ; 2.1 (2 kHz)
Directivity Index (DI)	5.1 dB (averaged 100 Hz - 10 kHz) ; 3.3 dB (2 kHz)
Transducer - Low-Frequency Driver	134 mm (5.25 in.) Polypropylene cone, rubber surround
Transducer - High-Frequency Driver	19 mm (0.75 in.) Silk dome tweeter
Low-Frequency Voice Coil	25.4 mm (1.0 in.)
Crossover Frequency	5.0 kHz
Network Type: Low Pass	12 dB per octave, 2nd order
Network Type: High Pass	12 dB per octave, 2nd order
Enclosure Material	Drawn steel backcan with ABS baffle
Grille	Painted steel
Inputs	RJ45 ethernet port
Colors	White
Backcan Diameter	245.6 mm (9.67 in.)
Backcan Height	146.1 mm (5.75 in.)
Visible Diameter	298.5 mm (11.75 in.)
Visible Height	8.6 mm (0.34 in.)
Mounting Hole Diameter	266.7 mm (10.5 in.)
Min - Max Ceiling Thickness	0.9 mm (0.035 in.) - 63.5 mm (2.5 in.)
Weight	3.6 kg (8.0 lbs.)
Shipping Weight	4.1 kg (9.0 lbs.)
Packaging	One per box
Included accessories	Tile bridge, UL-listed flex conduit clamp, paint shield
Optional accessories	Pre-construction bracket (AC-CM6/8-PCB)
Regulatory - UL	UL 60065 & UL 2043 listed
Regulatory - CE	Approved
RoHS	Approved

1. Frequency response measured in half or full space as dictated by speaker mounting configuration

2. Max output based on max continuous power

Preliminary Technical Information

- IP addressable, self powered (PoE) speaker.
- Dante™ I/O for interconnectivity with Dante-enabled audio systems.
- One 5.25 inch (134 mm) polypropylene woofer with rubber surround and one 0.75 inch (19 mm) silk dome tweeter.
- BroadBeam Ring™ technology for mid-range clarity and ultra wide off axis performance.
- Fast connection of power, audio and control functions via one CAT5 or CAT6 cable.
- 40 watts PoE provided by SoundTube STNet-Switch; also works with Standard PoE plus and PoE switches.
- Provides report-back on any problems via SoundTube software.
- Tuned port on baffle for added musicality and bass response down to 56 Hz (-10 dB).
- Incorporates a painted steel grille for lasting durability.
- SpeedWing™ clamping system is adaptable to material thicknesses ranging from 0.035 in. (0.9 mm) to 2.5 in. (63.5 mm).
- UL 60065 and 2043 listed.
- High-quality white painted finish. Custom colors available.
- Included accessories: Color-coded (green) tile bridge, UL listed conduit clamp, paint shield.
- Optional accessories: Color-coded (green) pre-construction bracket (AC-CMEZ6/8-PCB).

Description

The IPD-CM52-BGM is a 5.25-inch coaxial in-ceiling speaker for IP-addressable audio networks on the Dante platform. It incorporates a 5.25-inch polypropylene driver with butyl rubber surround and a 0.75-inch silk dome tweeter in a sealed drawn steel backcan with a tuned port. The speaker delivers frequency response of 56 Hz – 22 kHz (-10 dB) with consistent, broad high frequency dispersion supplied through SoundTube's proprietary BroadBeam Ring™ technology.

Power, audio and control are delivered to the speaker via a CAT5 or CAT6 cable; connection on the other end is made to the STNet-Switch, which provides 40 watts PoE (Power over Ethernet) to each speaker. Configuration and zoning of the speaker is done via software. Should any problem occur with the speaker during operation, it will

be reported immediately via SoundTube monitoring software.

Mounting hardware for the IPD-CM52-BGM is included and features SoundTube's SpeedWing™ constant-tension fixed-wing mounting system, along with a 21-gauge steel tile bridge which ensures rapid and secure installation in any drywall or drop-tile application. The tile bridge is color-coded to match the speaker. An optional pre-construction bracket is also available.

Applications

Developed for Dante audio platforms, the IPD-CM52-BGM is ideal for hotels, museums, education, retail stores, restaurants, airports or corporate installations. This speaker is based on SoundTube's CM-BGM series, which was engineered for high efficiency, good musicality and added bass response, so it is suitable for both background music and paging.

Patented SoundTube Technologies

SoundTube Entertainment and the MSE Audio Group constantly develop new technologies which enhance audio product performance. SoundTube Entertainment innovations are protected by multiple U.S. and international patents, which explicitly cover SoundTube dome, enclosure and dispersion technologies. The MSE Audio Group actively defends its patents in order to protect SoundTube resellers and end-users.

Technical Data and Specification Tools

Technical Data

SoundTube Entertainment strives to provide complete and effective technical information and data to dealers, engineers and designers. All data are available from SoundTube Entertainment or at www.soundtube.com.

Technical data and downloads include:
EASE™ data – 3-D polar plots.

EASE™ Address – 2-D modeling for distributed systems

Autodesk® Revit® software

Tech Sheets – Technical information and architectural specs for system engineers

SoundTubeSPEC™ – Proprietary speaker placement software

Independent Data

Acquisition and Verification

All data for SoundTube speakers is independently collected and verified by a third party. All data is collected and analysed according to ASTM, ISO and AES standards using EASERA, TEF and MLSSA. Full balloon data including both phase and magnitude is compiled into a variety of formats including EASE 4.x, GLL and CLF.

Architectural Specifications

The loudspeaker shall consist of one 134 mm (5.25 in.) low-frequency transducer and one 19 mm (0.75 in.) high-frequency transducer with a frequency-dividing network installed in a sealed enclosure. The low-frequency voice coil diameter shall be 25.4 mm (1.00 in.). The low-frequency transducer shall have a polypropylene cone material with a rubber surround. The high-frequency transducer shall be constructed of silk material using a balanced-dome configuration.

Performance specifications of a typical production unit shall be as follows: Usable frequency range shall extend from 56 Hz – 22 kHz (-10 dB). The frequency dividing network shall have a crossover frequency of 5 kHz. The unit shall accept 40 watts PoE in addition to PoE plus and standard PoE, as well as the audio signal from a provided network switch, and shall be configurable via software. Maximum continuous output at 1 meter with a 40 watt input shall be 99 dB.

The backcan shall be constructed of galvanized steel with an ABS plastic baffle. The grille shall be constructed of painted steel. Shipped complete with UL-listed flex conduit connector, color coded tile bridge (to match color-coded backcan), grille, and paint shield, the integrated in-ceiling speaker shall be engineered for high performance and rapid installation in plenum spaces.

The unit incorporates three additional attachment points for added security, or where required by code.

Installation for the speaker shall be by two-screw blind-mount constant-tension fixed-wing assembly and shall attach to ceiling thicknesses ranging from 0.035 in. (0.9 mm) to 2.5 in. (63.5 mm). The external wiring shall be via RJ45 ethernet port, accepting standard CAT5 or CAT6 ethernet cable.

The maximum backcan dimension shall be no more than 146.1 mm (5.75 in.) in height by 245.6 mm (9.67 in.) in diameter. The maximum visible dimensions shall be no more than 8.4 mm (0.33 in.) in height by 298.5 mm (11.75 in.) in diameter.

The system shall be the SoundTube IPD-CM52-BGM for Dante™ applications.

SoundTube Entertainment

6430 North Business Park Loop
Park City, Utah 84098
Phone 435.647.9555
Fax 435.647.9666
Toll Free 800.647.TUBE
www.soundtube.com

All SoundTube products come with a 5-year limited warranty.

Graphs

Frequency Response

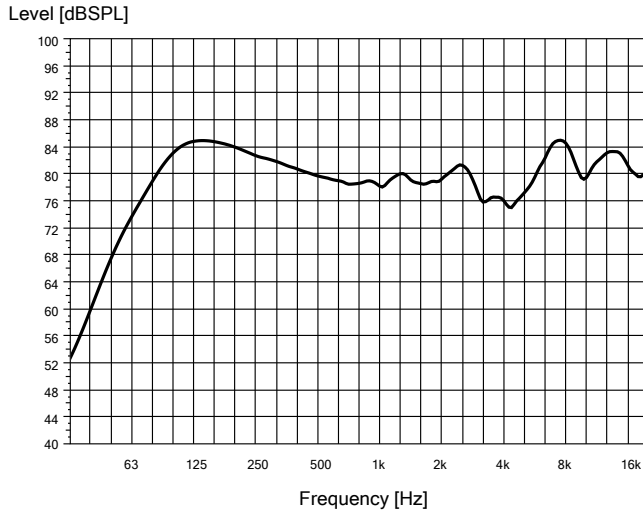

Phase/Impedance Response

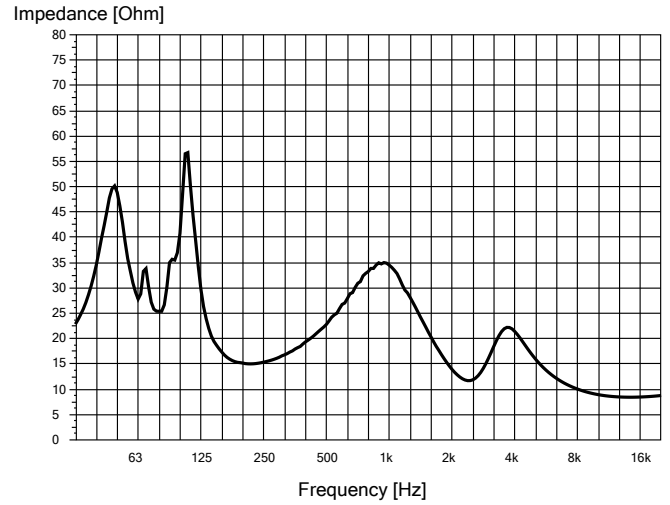

Vertical Beamwidth

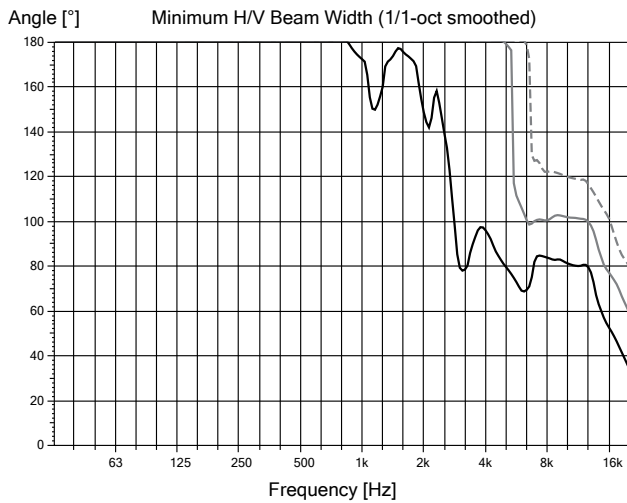

Directivity Index (DI)

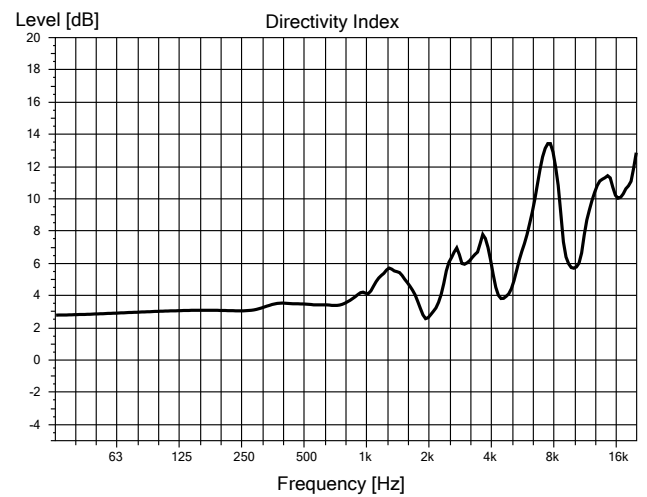



Polar Plots

— Horizontal
- - - Vertical

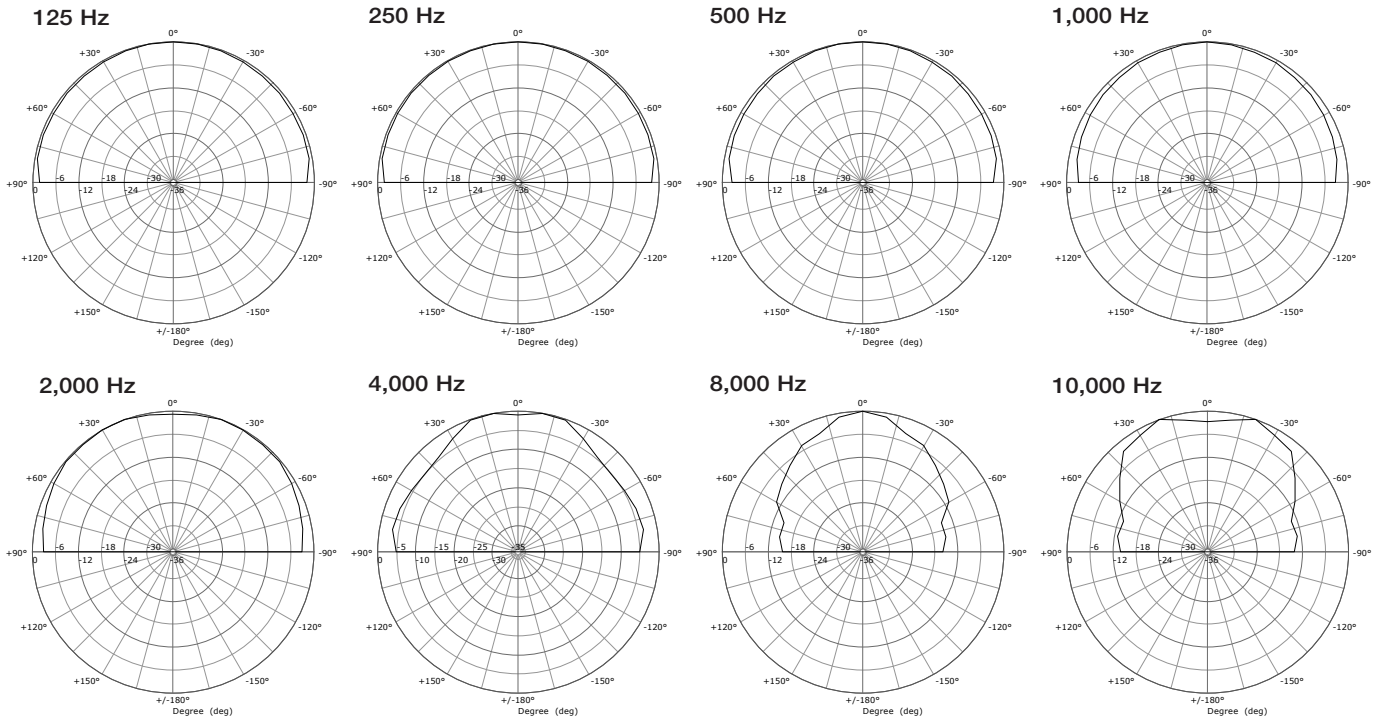

Technical data, EASE™ plots, SoundTubeSPEC™ software and product downloads available at www.soundtube.com

Mechanical Drawings

Side

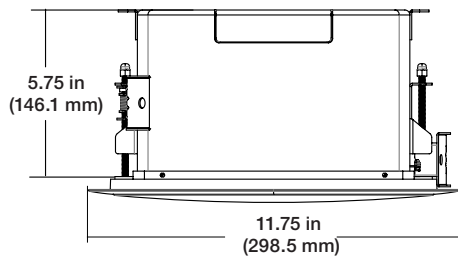

Top

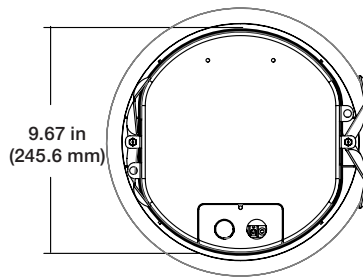

Included Accessories

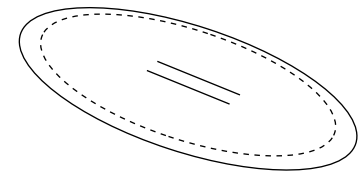

Paint Mask

23.55 in
(598.25 mm)

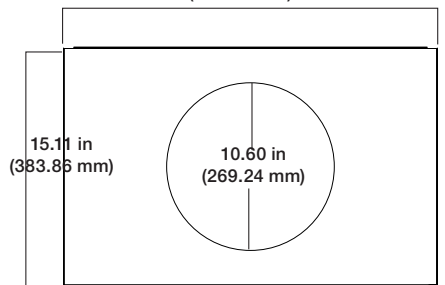

Tile Bridge

Optional Accessories

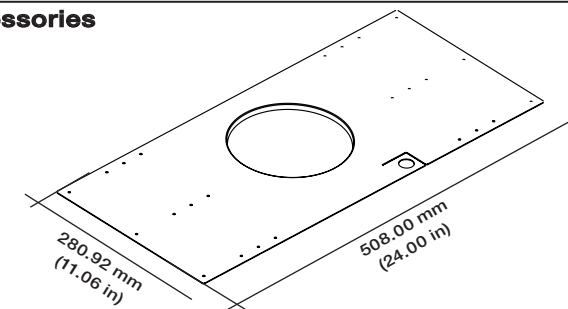

Pre-Construction Bracket (AC-CMEZ/8-PCB)

SoundTube Entertainment manufactures a complete line of speakers for:
Open-Ceiling • In-Ceiling • Surface-Mount • Outdoor • Sound-Focusing

All SoundTube products are designed and engineered in the USA.